



MegaRail Installation Manual

Table of contents

Section 1 - General Information

Scope
Quality Assurance
Durability
Product Design, Warranty and Liability
Training
Health and Safety

Section 2 - Design Requirements

Set back
Containment Levels
Working width
Vehicle Intrusion
MegaRail Systems Information
System Progression
Visibility
Sloping Ground
MegaRail Height
MegaRail Length
Post Foundations
Limitations on Use

Section 3 - Installation

Setting Out
Driven Posts and Driven Foundations
Concrete Foundations
Surface Mounted Posts
Smarcraft Compatibility
Steel Plate Foundations
Special Length Beams
Grout Beds
Ground Anchorages

We continuously strive to provide the most current and accurate information to our esteemed clients and readers. However, please be advised that the contents of this brochure are subject to change without prior notice.

For the most up-to-date information, details, and offerings, we strongly recommend visiting our website - www.saferoad-rs.com/uk.

Table of contents

Section 4 - MegaRail Assembly

N2, H1 and H2 Systems

Connection to TCB and OBB

MegaGuard

SafeFlex

Safe-End P1

Safe-End P4

Connection to Other Proprietary Systems

Installation on Curves

Installation in a Central Reserve

Installation at Slopes

Section 5 - Inspection, Maintenance and Repair

Inspection

Maintenance

Repair

Innovation

Section 6 - Driven and Foundation Post Testing Requirements

Ground Conditions

Soil Test Criteria

Recording Foundation Test Results

Section 7 - Post Foundation test Procedure

Testing Procedure

Push Testing Diagrams

Pressure Loading Chart

Section 8 - General Arrangement Drawings

Current Drawings

Limited Use Drawings

Steel Step Barrier Drawings



Section 1 - General Information

Scope

This manual sets out the procedures for the installation, repair, inspection, and maintenance of all MegaRail vehicle restraint systems, both new and in service supplied by SAFEROAD (inclusive of Mega Guard, terminals, transitions, steel step corridor & steel step barrier gates).

MegaRail has been designed and impact tested in accordance with the performance specification laid down in EN 1317 for classes N2, H1 and H2. The product range has been carefully selected and developed from the SAFEROAD broader range of systems to suit the requirements of the UK highways network and is compatible with all Non-proprietary Safety barrier Systems (NPSBS) and all reputable EN 1317 proprietary systems.

Quality Assurance

SAFEROAD are fully compliant with BS EN ISO 9001 and have procedures in place to ensure compliance with EN 1317. SAFEROAD are committed to providing quality products and services which fully comply with the specification.

Durability

SAFEROAD's Megarail products have a minimum serviceable life of twenty years, this covers all safety barriers, terminals, transitions and crash cushions.

Service life can be assured for areas of high corrosion risk or central reserve installations requiring a 50 year service-life can be accommodated but the customer must make the requirement known at the time of order.

Product Design, Warranty and Liability

The product assurances given by SAFEROAD for design, warranty, and liability for the MegaRail family of products will be invalidated if it is demonstrated that components have been used from an unapproved source in installation, maintenance or repair and if the VRS does not comply with SAFEROAD's specifications. Due to Saferoads research and development program, systems are evolving constantly, so before installation reference should be made to the Saferoad website to ensure that you are working to the latest drawings, If you have doubts or concerns seek confirmation from Saferoad.

When connecting to another safety barrier system we recommend that the screws in the joint or beam lap should be supplied by SAFEROAD unless the other promoter gives express permission to use their fasteners in which instance SAFEROAD will accept the connection if the system being connected to is fully tested and approved to EN 1317 or is an NPSBS safety barrier.

Training

SAFEROAD's policy is that all works to install, repair, inspect and maintain MegaRail VRS on UK roads must be undertaken by fully trained and properly qualified personnel in accordance with the mandatory requirements of Sector Scheme 10B and as specified in the Design Manual for Roads & Bridges (DMRB) volume 2 section 2 part 8, CD377 Requirements for Road Restraint systems (which has replaced TD 19/06), and the Specification for Highway works CC 400 and GG 101-7 quality management schemes. Sector Scheme 10B training is available from SAFEROAD's Lantra Awards approved training centre.

SAFEROAD's training policy extends to anyone installing MegaRail from outside of the UK who has already undertaken MegaRail training, therefore these erectors must also have the LANTRA basic training for safety barriers and meet the requirements laid out in the above documents. For details of available training contact SAFEROAD.



Health and Safety

It is the installer's responsibility to ensure that all necessary safety procedures are in place and always implemented. The site-specific conditions and restrictions should be assessed by the installation company and a risk assessment and method statement produced for the specific site. If mechanical lifting equipment is to be used to unload and / or move materials, then a lift plan must be prepared by a competent appointed person. All endeavours must be used to ensure that no one is injured or put at risk during the installation, repair, inspection, or maintenance of the MegaRail VRS systems.



Section 2 - Design Requirements

The installation, inspection and repair of the MegaRail family of products must comply with the requirements of The Specification for Highways Works CC 400, CD377 Requirements for Road Restraint systems, CD127, EN 1317 and SAFEROAD product specifications. It is important to note that whilst product specification is constant, the requirements of Highways Authorities across Europe will have differing constraints. This manual only takes cognisance of the requirements in the UK.

Set Back

Set Back should normally be as described in the table below, but the Design Organisation may use further relaxations in accordance with the notes on the table which is taken from CD127 2.24.

Location	Desirable Minimum Setback Value (mm)	Available relaxations at sites described in footnotes
In verges with no adjacent hard shoulder or hard strip	1200	Note (i), (ii)
In verges with an adjacent hard shoulder or hard strip	600	Note (iii)
Central reserves	1200	Note (i), (ii)
Design Organisations may, where justified, consider Relaxations to set-back as follows:		
I. Relaxation to 600mm for roads of speed limit 50mph or less (including temporary mandatory speed limits).		
II. Relaxation to 1000mm at existing roads with physical restraints (e.g. a structure) where it would be difficult to provide the desirable value.		
III. Relaxation to 450mm will be permitted where it is considered necessary to position the VRS away from the edge of an existing embankment in order to provide support to the foundation.		

If both set back and working width cannot be achieved, we recommend that set back should be reduced and working width maintained.

In central reserves where there are two single-sided safety barriers it must be ensured that the working width is maintained between the two.

Note: For either of the above situations, a departure from standard must be obtained from the overseeing authority, the exception to this is a bifurcation.

Containment Level

This is the type of vehicle the system is designed to retain at a given speed and angle of impact, see table below for the test criteria.

Containment level	Test Vehicle	Test Speed		Impact Angle
		KPH	MPH	
N2	1500kg Car	110	68	20 Degrees
	900kg Car	100	62	20 Degrees
H1	10,000kg Rigid HGV	70	44	15 Degrees
	900kg Car	100	62	20 Degrees
H2	13,000kg Bus	70	44	20 Degrees
	900kg Car	100	62	20 Degrees

The system identification is made up of the containment level and the working width for example N2 W2 for details of the available systems and the post centres please see the table on page 11 and the working width table below.

Working Width

The working width is the distance between the traffic face of the VRS and the furthest point of deflection and therefore a safety barrier should be selected to suit the location, see table below for working width classes

Classes of normalised working widths	Levels of normalised working widths
W1	≥ 600mm
W2	≥ 800mm
W3	≥ 1000mm
W4	≥ 1300mm
W5	≥ 1700mm
W6	≥ 2100mm
W7	≥ 2500mm
W8	≥ 3500mm
≥ is greater than or equal to	

Vehicle Intrusion (applicable to high containment systems only)

Consideration must be given to the available space behind the VRS system to ensure that the errant vehicle does not strike the obstruction when the system is impacted. Although a system may have a working width of $W2 \geq 800\text{mm}$ its class of normalised vehicle intrusion (VI) rating may be $VI4 \geq 1300\text{mm}$.

See sketch below.

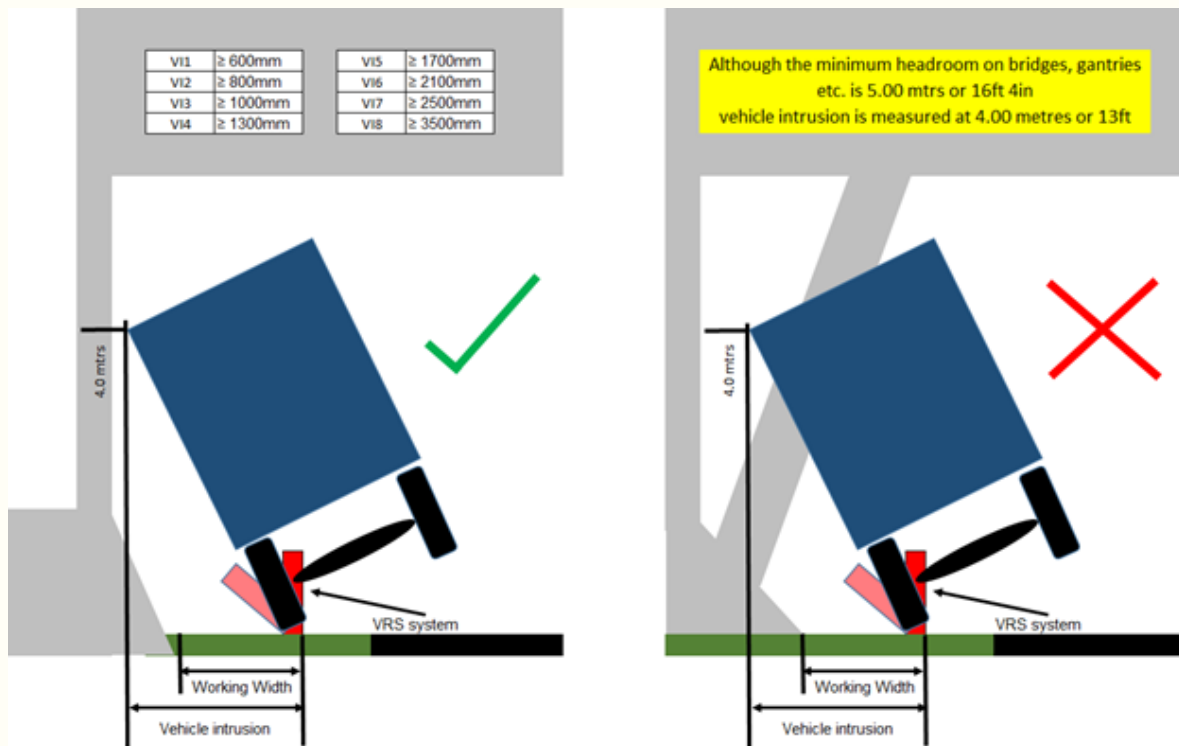

MegaRail systems Information

SYSTEM	Rating	VI Rating	Drawing Reference	Post Type	Std Post Centre's	System Height (mm)	Post Height (mm)	Beam Type	Torque Values For Fixings in Nm			
									M16 Lap Bolts	M16 Lap Bolts	Diameter of Post Bolt	Diameter of Post Bolt
ep	N2W1		MR-C120N2W1-GA-00	C120	2Mtr	750	700	3mm	70 to 140	70 to 140	M16	70 to 140
VIKCC2	N2W3		N2W3-GA-00	Sigma Type B	2Mtr	750	670	VIK 3mm	70 to 140	70 to 140	M12	10 to 17
VIKCC4	N2W3		N2W3-GA-00	Sigma Type B	4Mtr	750	670	VIK 3mm	70 to 140	70 to 140	M12	10 to 17
MR ep 5.0	N2W3		MR-ep5.0-GA-00	C100	5Mtr	750	700	2.5mm	70 to 140	70 to 140	M16	70 to 140
ep c/c 6	N2W4		ep N2W4-GA-00	C100	6Mtr	750	700	2.5mm or VIK 3mm	70 to 140	70 to 140	M16	70 to 140
xn	N2W4		MR-xn-GA-00	C125 x 125	6Mtr	750	745	Channel	70 to 140	70 to 140	M16	70 to 140
MegaRail BB	N2W5		MRBB-GA-00	Z or S	2400mm	710	710	3mm Box Beam	70 to 140	70 to 140	M10	10 to 17
MegaRail CB	N2W5		MRCB-GA-00	Z or S	3200mm	785	785	SRC 01 2.5mm	70 to 140	70 to 140	M8	15 to 20
MegaGuard	H2W1	VI3	H2W1-GA-00	H	2Mtr	1250	1245	3mm & Backing Beam	70 to 140	70 to 140	M16	70 to 140
sk	H2W2	VI2	H2W2-GA-00	C125 Type B	1Mtr	1100	1090	3mm	70 to 140	70 to 140	M10	10 to 17
bs	H1W2	VI3	H1W2-GA-00	C125 Surface Mounted	1333mm	700	595	3mm	70 to 140	70 to 140	M10	10 to 17
ex	H1W2	VI4	exH1W2-GA-00	C100	3Mtr	750	700	2.5mm	70 to 140	70 to 140	M16	70 to 140
Safestar 231	H2W3	VI3	H2W3-GA-00	C125 Type C	1500mm	900	790	Tri-Wave	70 to 140	70 to 140	M10	10 to 17
ep	H1W3 N2W2	VI5	N2W2/H1W3-GA-00	C100	4Mtr	750	700	2.5 mm	70 to 140	70 to 140	M16	70 to 140
xp	H1W3 N2W2	VI4	MR-xp-GA-00	C125 x125	2250mm	750	745	Channel	70 to 140	70 to 140	M16	70 to 140
ec	H1W3 N2W2 H2W4	VI4 VI6	H1W3-GA-00	C125 with strap	1333mm	700	595	3 mm	70 to 140	70 to 140	M10	10 to 17
xo	H1W4 N2W3	VI5	MR-xo-GA-00	C125 x 125	4.5Mtr	750	745	Channel	70 to 140	70 to 140	M16	70 to 140

System Progression

A minimum of four metres of each working width must be used to maintain progression, excluding the MegaFlex/SafeFlex transitions, P4, P2 & P1 terminals where the full length must be installed.

SYSTEM CONNECTION COMPATIBILITY	NPSBS			MegaRail Systems																							
	N2W6 TCB	N2W5 OBB	N2W4 OBB	N2W5 MegaRail BB	N2W5 MegaRail CB	N2W4 ep cc6	N2W4 xn	N2W3 VIK CC2 & CC4	N2W3 / H1W4 xo	N2W3 ep 5.0	N2W2 / H1W3 ep	N2W2 / H1W3 xp	N2W1 ep C120	H1W3 / N2W2 / H2W4 ec	H2W3 Safestar 231 (via progression)	H1W2 ex	H1W2 bs	H2W2 sk (via progression)	H2W1 MegaGuard	Safeflex Transition	P4 Safe-End	P1 Terminal	P2 Safe-End	P2 Primus 2a	Arcus Primus 90		
N2W6 TCB	█																										
N2W5 OBB		█																									
N2W4 OBB			█																								
N2W5 MegaRail BB				█																							
N2W5 MegaRail CB					█																						
N2W4 ep cc6						█																					
N2W4 xn							█																				
N2W3 VIK CC2 & CC4								█																			
N2W3 / H1W4 xo									█																		
N2W3 ep 5.0										█																	
N2W2 / H1W3 ep											█																
N2W2 / H1W3 xp												█															
N2W1 ep C120													█														
H1W3 / N2W2 / H2W4 ec														█													
H2W3 Safestar 231 (via progression)															█												
H1W2 ex																█											
H1W2 bs																	█										
H2W2 sk (via progression)																		█									
H2W1 MegaGuard																			█								
Safeflex Transition																				█							
P4 Safe-End																					█						
P1 Terminal																						█					
P2 Safe-End																							█				
P2 Primus 2a																									█		
Arcus Primus 90																										█	

Visibility

The design layout of the MegaRail shall comply with the sight distance requirements set out in CD109 (section 3) which has replaced TD 9.

Sloping Ground

The ground below the MegaRail shall be near level within the set back and working width, maximum slope is 5% or 1 in 20.

MegaRail Height

The MegaRail systems should be set to the heights shown on the drawings with a tolerance of plus or minus 50mm for all systems. Where the kerb height is less than 100mm and the distance between the face of the beam and the edge of the adjacent paved area is less than 1.5m, the height should be measured from the edge of the paved area.

Where the kerb height is less than 100mm and the distance between the face of the beam and the edge of the adjacent paved area is greater than 1.5m the height should be measured from the ground beneath the beam. See drawing MR-GA-001.

On all MegaRail systems where the kerb height is more than 100mm and the distance between the face of the beam and the edge of the adjacent paved area is less than 250mm the height should be measured from the edge of the paved area.

Where the kerb height is more than 100mm and the distance between the face of the beam and the edge of the adjacent paved area is 250mm or greater the height should be measured from the top of the kerb or adjacent ground level.

See drawing MR-GA-003

See notes on system drawings to determine which method to use.

MegaRail Installation and Maintenance Tolerances		
	Installation Tolerance	Maintenance Tolerance
Height	+/- 50 mm	+/- 75 mm
The maintenance tolerance can be used during installation when the safety barrier height reference is changing from carriageway to verge level or when connecting to an existing VRS.		
Alignment	+/- 30 mm	+/- 30 mm
Post Centres	+/- 100 mm	+/- 100 mm

MegaRail Lengths

The minimum length of MegaRail required to meet the length of need FOR N2, H1 or H2 systems are shown on our drawing numbers MR-GA-042 & MR-GA-043.

Where MegaRail is being erected between other VRS systems, for example between two parapets, the minimum length can be to suit the need. EN 1317 states: the length of the safety barrier tested shall be sufficient to demonstrate the full performance characteristic of any longer length. It does not require a minimum length of installation.

Post Foundations

The type of post foundation used will be dictated by the ground conditions on the site. As a rule, soil type ground properly compacted will allow the use of driven posts or driven foundations. The suitability of driven posts or foundations must be established by following the SAFEROAD testing procedure for MegaRail driven posts or foundations.

Where site conditions preclude the use of driven posts, the posts may be surface mounted or set in concrete foundations.

When using surface mounted posts, the anchors must be proven by applying the test loads set out in the SAFEROAD testing procedure for surface mounted MegaRail posts. When not using Saferoad standard details, the contractor must also prove by calculation that the foundation will resist the overturning moment and that the posts will become plastic before any movement in the foundation occurs at the initial type test angle as described in EN 1317.

For posts set in concrete foundations the same test criteria applies as for driven posts. However, this does not ensure a survivable foundation. A compliant foundation which will pass the soil test can move under impact such that it may need to be replaced when the VRS is repaired.

We recommend that survivable foundations are designed and installed wherever practical. We would suggest this is clarified with the scheme designers.

Limitations on Use

MegaRail VRS must be installed in accordance with this manual, current MegaRail drawings, BS EN 1317, series CC 400 MCHW, CD377, CD127 and CD109.

Refer to CD377, MR-GA-42 & MR-GA-43 for minimum lengths. Refer to section 4 for installation on curves.



Section 3 - Installation

It is the installers responsibility to ensure that they are working to the current revision of the manual and drawings. These can be found at

www.saferoad-rs.com/uk

Setting Out

Establish the length of need both in advance and on departure from the hazard excluding terminal lengths. Set out the post pitches ensuring that the length of need is covered. If there are any obstructions on the fence line and if the site conditions do not allow a post to be installed on the system pitch, deviations can be applied. The obstructed post can be omitted, and extra posts installed to span the obstruction.

Please note that each system has different rules so refer to each system drawing GA-40 for details as to what deviations are allowable for the system being installed.

Although it would be beneficial to use the holes already in the beam it is acceptable to drill new holes on site in the desired position and treat the beam with a zinc rich paint to comply with the galvanising specification BS EN ISO 1461.

Another method of deviating is by using an offset post. The posts can be manufactured to suit the location within the following parameters, the base plate must be a minimum of 50mm thick and the offset plate no longer than 700mm. Refer to each system drawing GA-00 for details. The post pitch must return to the correct system position within 8 metres of the last correctly positioned system post and remain correctly positioned for a minimum of 4m or 3 post pitches, whichever is the greater.

If obstacles cannot be circumvented by these methods it may still be possible to provide a compliant design, please contact our technical department whose details can be found at the end of this manual.

If a bridge expansion joint is to be spanned, then a pre-assembled expansion beam assembly should be installed as per drawing MR-GA-025. Where system progression is required, the progression should be by only one working width at a time. i.e., N2 W3 to N2 W2 or N2 W3 to N2 W4.

Special Length Beams

It is often necessary to provide special length beams for safety barrier installations. Saferoad will certify the onsite fabrication of special length beams when the following procedure from BS EN ISO 1461 is followed.

Areas of unprotected steel shall be renovated by either:

- A suitable zinc-containing paint with zinc dust pigment.
- A suitable zinc-containing paint with lamellar zinc pigment.
- A suitable paste product or zinc alloy stick.

The repair treatment shall include the removal of any scale, cleaning and any necessary pre-treatment to ensure adhesion. The repair coating thickness shall be a minimum 100µm.

The cutting of posts is not permitted under any circumstance.

Driven Posts

Before any post driving is considered the area should be thoroughly checked for the presence of services. Wherever it is practicable, the installation of VRS over services should be avoided. We would recommend a minimum of 500mm safe working distance between driven posts and adjacent services.

Driving times of more than 3.5 minutes for each post indicate that the ground conditions are too hard and excessive damage may occur to the posts and therefore in these circumstances concrete foundations should be used as an alternative to driven posts. Examples of excessive damage are Serious splitting of post top, distortion of preformed post holes.

Unless the driven post has suffered significant deformation, it is unlikely to lead to any detrimental effect on the VRS performance.

Posts may be up to 5 degrees out of vertical alignment and up to 5 degrees out of rotational alignment without affecting the performance of the system.

On rotational alignment, the face of post must be in contact with the beam for more than 75% of designed contact area.

It is also important to be aware that post damage does not only occur above the ground where it can be seen, hard ground conditions can cause an unacceptable amount of damage in the ground where it is not readily detectable.

Saferoad have developed a driven foundation which can be driven as a post is but is used as a socket. It is soil tested to the same standards as a concrete foundation

Concrete Foundations

Before any excavation is considered the area should be thoroughly checked for the presence of services. Wherever excavation is with a machine bucket, it is preferable that the bucket should not be fitted with teeth.

The foundation design and size should be established by the installation of test foundations before the actual permanent foundations are constructed.

The test foundation should be designed so that the risk of displacement under impact is avoided when struck at type test angle.

Establish post centres and excavate foundations to the size established. When constructing the foundations ensure there is a minimum of 100mm of concrete cover to all sides of the post or post socket (70mm on augured foundations). It is advisable to have some socket length protruding from the finished concrete level and up to 100mm is acceptable.

Where the sides of the excavation cannot be kept vertical then suitable permanent or temporary casings shall be used.

Place concrete in the foundation. Concrete should be able to resist the plastic moment of the post when loaded at 90 degrees (the post's strongest axis) RC20/25 is the minimum grade of concrete- ST5 is an accepted alternative prescribed concrete.

Put the post and socket (if required) into the concrete, install the reinforcing ring and set the post to line and level. Make final adjustments to height and line before the initial set of the concrete. Slope the concrete away from the post and socket to help avoid corrosion where possible.

The socket should be protected from the incursion of detritus by use of a filler such as expanding foam. (See series CC 400, Clause 3.13)

Where the concrete foundations are in filter drains, they may require casings. The outside of the casing should be backfilled with uncontaminated filter media on the line of the filter drain and backfilled with the excavated spoil elsewhere. A plastic membrane of at least 125 microns thick should be laid at the base to prevent contamination of the filter media. In some filter drains casings may not be required as the filter drain "stands up" and maintains vertical sides unaided. Consideration should be given by all parties on the best method of preventing contamination of the filter media, whilst taking into consideration that in certain circumstances contamination may not be an issue.

It is critical when determining the size of all test foundations that the lack of ground support is considered, and the foundation is of sufficient volume to support the post and allow it to become plastic before the foundation is levered clear of the surrounding ground when the VRS is struck at the type test angle.

Surface Mounted Posts

Surface mounted posts are normally only used in locations where driven or posts in sockets are not practicable, and therefore are often mounted on a concrete slab of limited thickness. It must be ensured that such a slab is adequately reinforced and can resist the overturning forces incurred under impact at the initial type test angle. When not using Saferoad standard detail, This should be demonstrated through calculation and a design submitted to the overseeing authority for approval or by using Saferoad standard details.

The foundation should be excavated to the correct depth in a continuous length to at least the minimum length the design permits. Sides should be shuttered where required and the reinforcing steel set in place. Reinforcing should be designed in such a way that it is compatible with the use of SAFEROAD anchorage systems which is the preferred method of anchoring in a purpose-built foundation. However please note resin anchors can be used.

Concrete should be placed directly from the delivery truck and compacted using vibration; posts on anchorages should be placed before the initial set of the concrete and set to line and level, the concrete should be re-vibrated around the anchorage after it has been placed in the concrete to ensure there are no voids.

Where the design organisation has deemed existing construction to be suitable to provide a foundation for surface mounted posts the posts will be installed on drilled anchors.

The anchorage system must be installed in accordance with the manufactures instructions and tests must be carried out as specified in BS 5080 Part 1 to ensure the required strength has been achieved, see table on page 20

The frequency of the tests will be as specified in the contract, but not less than detailed in CC 400 clause 3.43.

It is critical when fitting resin anchors that the holes are drilled to the correct diameter and depth then thoroughly cleaned using clean compressed air and or brushes.

When the resin anchor has cured, fasteners should be tightened to the minimum torque and thread engagement. Posts should be sat on a grout bed of between 10 and 30mm where the concrete conditions dictate. Alternatively, a plastic bed with a compressive strength in excess of the plastic moment of the post may be used.

When the grout has set the anchors should be tightened to 60 to 80Nm

Surface mounted posts should be manufactured to the correct height for the location the use of detachable height adjusters is not permitted.

For pull testing loads for ground anchorages see the table on the next page

Test Loading Chart for Surface Mounted Posts

System	Containment Level	Post Type	Test Load
SafeFlex	N2W1	C125 x 125	80Kn
ep	N2W1	C120	80Kn
ep	N2W2	C100	50Kn
VIK CC2 & CC4	N2W3	Sigma Type B	20Kn
MR ep 5.0	N2W3	C100	50Kn
ep c/c	N2W4	C100	60Kn
MegaRail CB	N2W5	SR A18	40Kn
MegaRail BB	N2W5	SR A18	40Kn
MegaFlex	N2W4	160mm x 45mm "Z"	70Kn
All 'x' systems	Various	C125 x 125	80Kn
MegaGuard	H2W1	H	80Kn
sk	H2W2	C125 Type B	60Kn
bs	H1W2	C125 Surface Mounted	50Kn
ex	H1W2	C100	50Kn
ep	H1W3	C100	50Kn
Safestar	H2W3	C125 Type B	60Kn
ec	H1W3	C125 Type B	60Kn

The purpose of a cementitious grout pad underneath a Saferoad VRS post is to remove or smooth out any deviations in the concrete surface on to which the posts are being anchored. The grout pads are not intended to fortify or provide any significant structural benefit to the VRS system. For this reason, the thickness other than where a crossfall dictates should not exceed 30mm. Grout pads are only required where the concrete surface dictates, posts can be placed directly onto the concrete surface if a smooth and flowing alignment can be maintained.

Grout pads are not required to ensure the service life of the system.

A grout pad which when cast is sound in appearance, free from crumbling will provide a good base for the posts and allow the system to perform as intended. Please note that Saferoad recommend grout pads should be removed and replaced after impact regardless of the procedure followed during the original installation. If there is concern for any reason about the suitability of a grout pad a soil test can be performed by loading the posts as described in the Saferoad MegaRail manual section 7, using the applicable load for the system. It is acceptable for the pad to demonstrate some crumbling, but it should not completely disintegrate. Any sudden collapse of the grout pad is not acceptable.

Smarcraft Compatible Systems

SYSTEM	CONTAINMENT	WORKING WIDTH	N/AVIN/A	SURFACE MOUNTED	PINNED POST
MegaRail ep C120	N2	W1	N/A	✓	✓
MegaRail ep	N2	W2	N/A @ N2	✓	✓
MegaRail VIK cc2/cc4	N2	W3	N/A	✓	✓
MegaRail ep 5.0	N2	W3	N/A	✓	✓
MegaRail ep cc6	N2	W4	N/A	✓	✓
MegaRail xp (DS System)	N2	W2	N/A @ N2	✓	✓
MegaRail xo (DS System)	N2	W3	N/A @ N2	✓	✓
MegaRail xn (DS System)	N2	W4	N/A	✓	✓
MEGARAIL CB & BB	N2	W5	N/A	X	✓
MegaRail ex	H1	W2	VI5	✓	✓
MegaRail ep	H1	W3	VI4	✓	✓
MegaRail xp (DS System)	H1	W3	VI4	✓	✓
MegaRail xo (DS System)	H1	W4	VI5	✓	✓
Safestar 231	H2	W3	VI3	✓	✓
TERMINALS	CLASSIFICATION	REDIRECTION ZONE	VI	SURFACE MOUNTED	PINNED POST
Safe-End P4	P4	Z1	N/A	✓	X
Safe-End P2	P2	Z1	N/A	✓	X
BOS Primus 2a	P2	Z1	N/A	✓	✓
TRANSITIONS / DRAWING NO	CONTAINMENT	WORKING WIDTH	VI	SURFACE MOUNTED	PINNED POST
Safeflex 120/140 & Safeflex - MegaGuard (UK27461)	N2	W1	N/A	✓	✓
MR-GA-40 MegaRail to OBB	N2	W4	N/A	✓	✓
MR-XO-GA-42	N2	W3	N/A	✓	✓
EPN2W4-GA-41	N2	W6	N/A	✓	✓
H2W1-GA-22	H2	W1	VI1	✓	✓
H2W1-GA-23	H2	W1	VI1	✓	✓
H2W1-GA-25	H2	W1	VI1	✓	✓
H2W1-GA-26	H2	W1	VI1	✓	✓
H2W2-GA-53	N2	W2	N/A	✓	✓
MR-XP-GA-42	H1	W3	VI4	✓	✓
H2W3-GA-52	N2	W2	N/A	✓	✓

Steel Plate Foundation

It is becoming increasingly common to install a conventional safety barrier across a structure in front of an existing parapet. This inevitably leads to conflict between anchorage positions and the reinforcement within the structure. There can also be an issue where ducts have been cast into the bridge and sit on the line of the VRS at minimum setback and working width. There are limited options to overcome these issues.

1. Cut through the reinforcing. Possibly compromising the structure.
2. Fill any ducts with concrete. Not guaranteed to be successful.
3. Introduce a secondary foundation which can be anchored to the bridge and is able to receive the VRS post at its prescribed location.

In many instances the only acceptable option will be the 3rd solution.

This involves fixing a steel plate to the structure (See drawing MR-GA-026) anchored by 4 number M20 A4-80 internally threaded stainless steel anchorages resin bonded. The position of these anchorages can be adjusted to avoid damage to reinforcement and or ducts.

The plate should be positioned so that the VRS post which is fixed to the 4 threaded M20 holes is in the correct position. Once this is done any of the multiple anchorage holes can be used to secure the plate foundation to the structure. In this way damage to the structure is avoided.

The adequacy of the foundation plate should be confirmed by performing a pull-out test equal to that applicable to the system which will be installed (refer to loading table on page 20) and also, a push test on the surface mounted post equal to the load required for the system which the plate is acting as a foundation for (refer to Pressure loading chart on page 39).

Ground Anchorages

Anchorage used on a bridge deck or other designated structure shall be stainless steel designation 1.4401, 1.4436, 1.4362 or duplex stainless steel designation 1.4362, to BS EN 10088-5.

Holding down bolts shall be stainless steel grade A4-80 to BS EN ISO 3506-1. Where not on a bridge deck or designated structure anchorages may be galvanised threaded bar grade 8.8.

Safe-End P4 Terminal



MegaFlex Transition to Aluminium Parapet

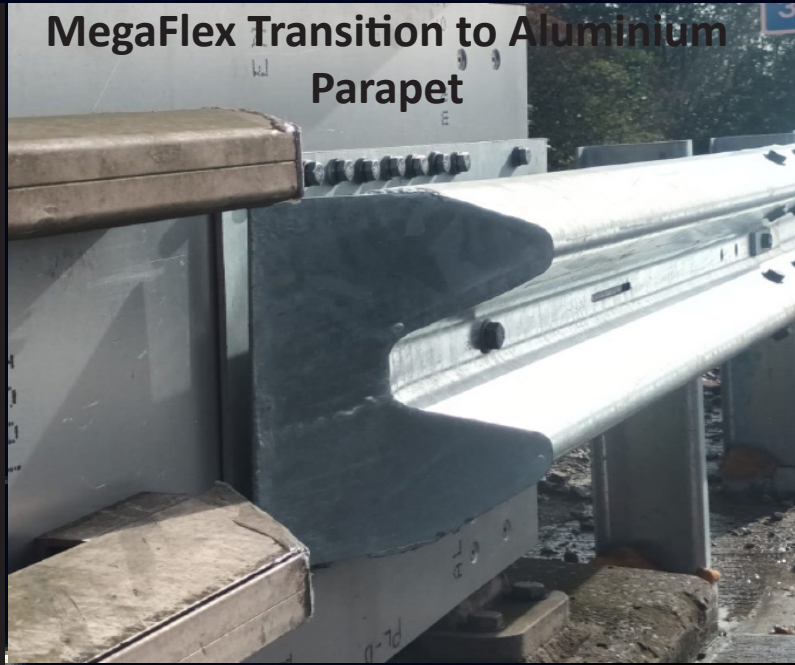

MegaGuard H2W1



**Section 4 -
MegaRail Assembly**

N2, H1 and H2 Systems

Posts must be set as described in section 3 and the post pitches and positions must be as the system drawings dictate.

Beams should be hung on the posts using the correct fixing hand tight only. Beams must be hung in the correct orientation so that the teardrop holes in the beam are over the top of the circular holes in the adjoining beam. The system is innovative in design to ensure there is no requirement for slack removal using tapered bars. The beams are fastened with MegaRail M16 lap bolts. For diameter of the post bolts and all torque settings refer to the MegaRail manual.

Pedestrian or motorcycle protection should be fitted if it is required as the system is assembled.

An inspection of the safety barrier should be carried out using an inspection check list, an example of a checksheet can be seen on page 30, taking into account the tolerances detailed in the table within section 2 on page 13.

NOTE: WHEN SECURING MEGARAIL FASTENERS, A MINIMUM OF ONE THREAD MUST APPEAR THROUGH THE NUT.

Connection to TCB and OBB

For connection to either TCB or OBB please see MegaRail drawing MR-GA-040. The system requirements for both NPSBS and MegaRail must be adhered to. When connecting to either TCB or OBB, the correct system progression must be maintained. If connecting to TCB there must be an adjuster assembly in the TCB within 35m of the connection. Connection to OBB should be made using an A06 connection piece.

A06 Connection piece

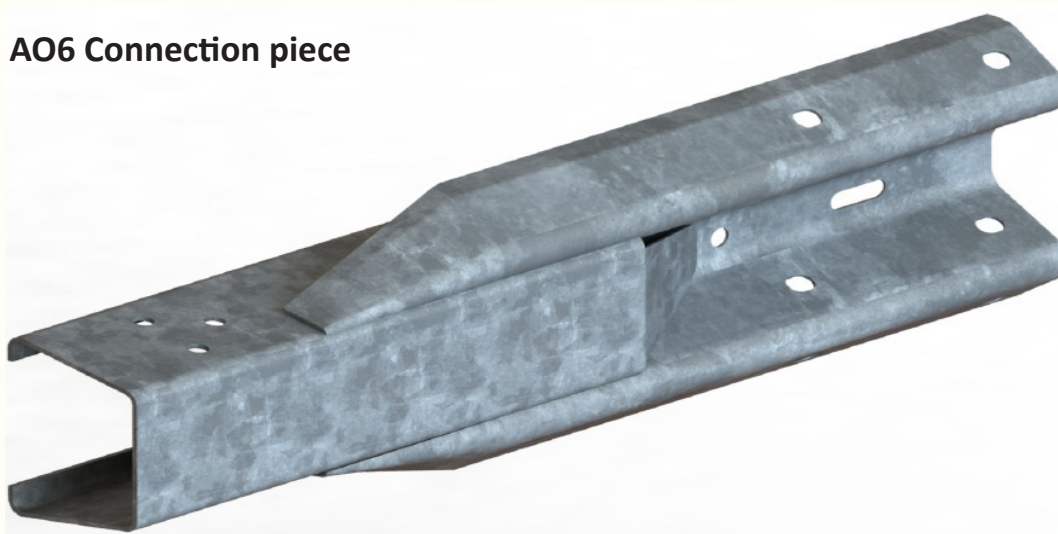

MegaGuard

MegaGuard should be installed on a concrete foundation, minimum length of slab/trench detail as stated in General Note 6 on drawing H2W1-GA-11.

When installing MegaGuard at standard 2 metre post spacings or using permissible deviations, singular foundations may be used. The minimum size and type of foundation will be determined by following the post foundation testing procedure.

When using surface mounted posts, these should be installed with SAFEROAD anchorages if wet set, or a suitable proprietary resin anchor system if using a drill and fix method.

Posts are to be set on a grout bed of between 10 and 30mm.

Beams should be hung on the posts using the correct fixing hand tight only.

Back Beams must be hung in the correct orientation so that the arrow follows the flow of traffic.

The beams are fastened with MegaFlex M16 lap bolts which should be tightened to between 70 and 140Nm. Post bolts should be tightened to between 70 and 140Nm.

When Mega Guard is installed as a safety barrier it may also be set in sockets. However, when used as a parapet system it may only be set on base plates.

SafeFlex Transition

There are 3 Types of SafeFlex transition: -

1. SafeFlex to MegaGuard
2. SafeFlex to Aluminium Parapet
3. SafeFlex to Steel Parapet

Posts must be set as described in section 3. Post pitches must be as the system drawings, deviations within the transition are not permitted.

Beams should be hung on the posts using the correct fixing hand tight only. The beams are fastened with M16 x 27 domehead lap bolts which should be tightened to between 70 and 140Nm.

The M16 x 45 Post bolts should be tightened to between 70Nm and 140Nm.

Safe-End P1

The Safe-End P1 can be installed on either driven or concrete foundations. The soil suitability should be established by applying the following test. A bending moment of 6.5 kNm (6500Nm) must be achieved before the post's deflection exceeds 100mm, see sections 6 and 7 of this manual. In all circumstances the post nearest the adjoining VRS should be the test post, or a sacrificial post in the same area.

Please note if test data already exists from the adjoining VRS then this is acceptable as confirmation that the ground conditions are suitable for the P1.

The Safe-End P1 can be used on high-speed roads on the departure end of a VRS. or where the speed limit is less than 50mph on both approach and departure ends of a VRS.

Refer to System progression chart on page 12 for compatible systems.

Safe-End P4

The Safe-End P4 can be installed on either driven foundations, concrete foundations or surface mounted, a foundation size of 450mm diameter by 1200mm deep should be sufficient.

The soil suitability should be established by applying the following test. A bending moment of 9 kNm (9000Nm) must be achieved before the post deflection exceeds 150mm measured at a height of 610mm, see sections 6 and 7 of this manual.

Please note if positive test data already exists from the adjoining VRS then this is acceptable as confirmation that the ground conditions are suitable for the P4.

If there is no test data for the adjoining VRS then a sacrificial post will be needed to be installed to allow testing.

Refer to system progression chart on page 12 for connection compatibility.

Where the Safe-End P4 is being installed over shallow drainage or other obstruction it is advisable to reduce the length of the anchorage nail to an absolute minimum of 800mm, the cut end of the nail should be treated with zinc rich paint in accordance with the galvanising specification BS EN ISO 1461. The shortened nail should be set in a concrete foundation of not less than 500mm square x 900mm deep.



The P4/ P2 terminals will be issued with a small prismatic decal (bottom R/H of image) The decal should be affixed as shown, this will act as a minor impact indicator. The decal should be affixed as close to the vertical of the terminal strap (as shown in image) Any minor impact or 'travelling' of the terminal head will be noticeable by any encroachment into the decal by the vertical strap edge. If this occurs, the terminal will require replacing.

Connection to other Proprietary Systems

SAFEROAD have such confidence in the MegaRail family of products and their total compliance with EN 1317 that they are willing to allow connection to any other reputable EN 1317 system that has been correctly tested and where the promoters of that system confirm their product will perform correctly up to but not including the joint.

SAFEROAD will guarantee the joint if it has been connected using our fixings and is in specification. We will not, however, guarantee the performance of the other system. It is critical that in the area of the connection, post centres are correct for both systems. Deviations should be at least 8 metres from the joint.

Installation on Curves

On curves with a radius greater than 50 metre standard beams can be used. On 30 metre radii to 50 metre radii 2 metre beams may be used.

On 5 metre to 30 metre radii pre-formed radius beams must be used. Radii less than 5 metre cannot be achieved.

No pre-formed radius beams can be used on systems with post spacings greater than 4 metres for example N2W4 EP c/c which has 6 metre post spacings.

The normal system progression rules must be applied either side of any radius.

MegaGuard cannot be used on radii less than 80 metre.

MegaFlex Transition does not have a radius option and must be installed in a straight line for the section that contains the backing beam, it then can be flared up to a maximum of 250mm.

SafeFlex Transition can be installed on a radius of 8 metres to 50 metres using pre-formed beams.

For a radius above 50 metres standard SafeFlex components can be used, SafeFlex transitions can not be installed on a radius below 8 metres.

Installation in Central Reserves

For central reserves to achieve a 50-year service life (as outlined in CD377) and areas where additional corrosion protection is required, enhanced galvanising will be necessary. It is vital the customer makes this requirement clear when ordering materials. Materials with increased corrosion resistance will be identified by labelling on the pack. It is the customers responsibility to ensure these materials are kept separate from materials with standard corrosion protection.

Installation at Slopes

Figure 3.39 Safety barrier location relative to the top of a slope that exceeds 200 mm in height

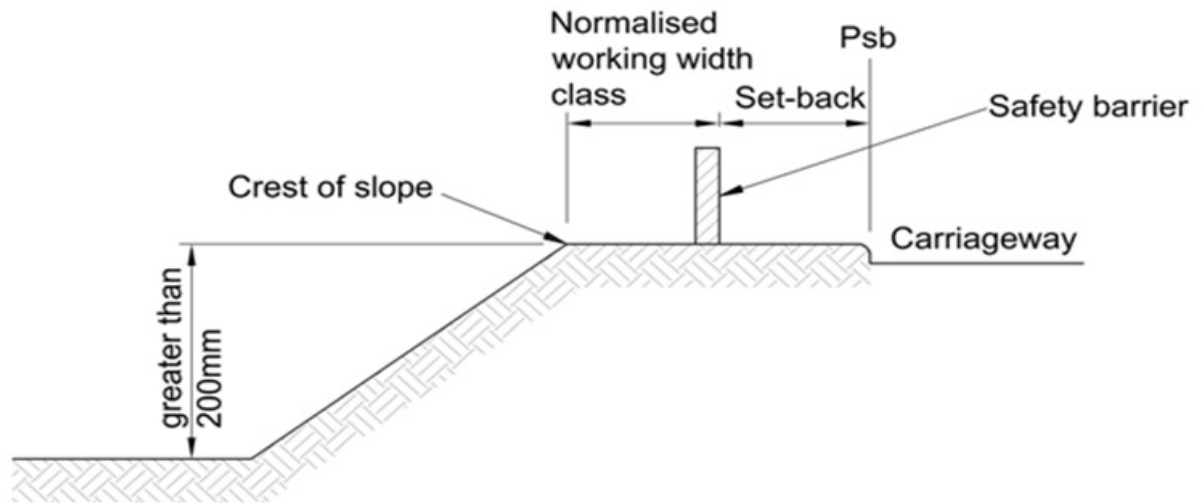

3.40 On embankments and sidelong ground where the proximity of the safety barrier to the crest of the slope and/or the ground conditions are likely to affect the integrity of the barrier, any restrictions on the distance of the post to the top of slope in the safety barrier manufacturer's product description and associated installation instructions shall be included as a design output under ground conditions.

3.41 The toe of a slope that exceeds 200mm in height shall not be within the normalised working width class of the safety barrier, as shown in Figure 3.41, unless permitted by the safety barrier manufacturer's product description and associated installation instructions.

Figure 3.41 Safety barrier location relative to the toe of a slope that exceeds 200 mm in height

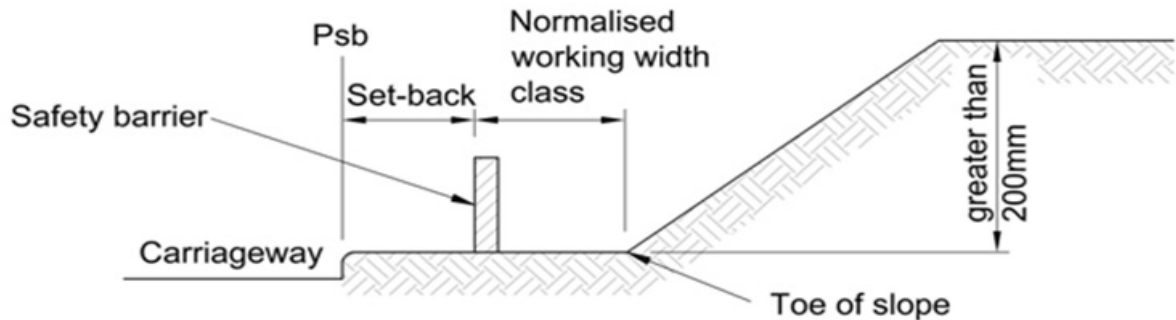

The crest of a slope exceeding 200mm may be within the working width of the system but must be no closer than the recorded dynamic deflection minus 100mm.

For example, if the dynamic deflection of a system is 500mm the traffic face of the system can be no closer than 400mm from the crest of the slope.

The exception to this is MegaGuard which can be installed at the crest.

The toe of a slope exceeding 200mm must not be within the normalised working width of the system.

The exception to this is MegaGuard which can be installed against the toe.



Section 5 -
Inspection, Maintenance
and Repair

Inspection

One of the MegaRail inspection certificates shown below should be completed for each VRS fence and submitted to the client to confirm the system has been inspected and is certified as compliant. The installation must be checked and certified as compliant using the system drawings. Specification and compliance with the contract drawings should also be agreed.

Where

installation differs from the contract drawing the reason should be documented. The system will not be deemed compliant unless certified by a suitably qualified person who can demonstrate competence. Either through LANTRA training or approval from SAFEROAD.

VRS INSPECTION CERTIFICATE

DATE:	
CONTRACTOR:	
CONTRACT:	
LOCATION:	
TYPE OF BARRIER:	

Within Specification				
CHECKS	YES	NO	N/A	COMMENTS
SET BACK				
WORKING WIDTH				
HEIGHT				
SYSTEM PROGRESSION				
FASTERS				
TERMINALS				
BEAM				
POSTS				
FOUNDATIONS				SIZE:
ID MARKINGS				

I confirm that I have checked the safety barrier in the above location and confirm that the inspected work has been completed in accordance with the specification.

Signed on behalf of installer	Signed on behalf of Contractor/Client (when applicabe)	
Lead Fencer or Supervisor	Main Contractor	Client
Name (Print):	Name (Print):	Name (Print):
Signature:	Signature:	Signature:
Date:	Date:	Date:

Maintenance

A correctly installed and certified MegaRail VRS is maintenance free for the period of its design life. A visual inspection regime is recommended to check for impact damage. Where this is identified, repairs must be carried out.

The visual inspection should also look at the ground conditions as erosion, slippage or ponding water can all affect the viability of a VRS and therefore must be maintained in good order.

Repair

When repairing MegaRail VRS only components with visual residual plastic deformation need to be replaced. If the deformation is minor damage to a beam and is localised, then replacement is not necessary other than for aesthetic reasons.

Minor damage could be small scratches and indentations which should be treated with a zinc rich paint. Substantially damaged beams must be replaced as must any bent posts. The bolt holes in adjacent beams should be checked for splitting or distortion and if any are identified those beams should also be replaced.

The repaired installation should be checked for compliance with the system specification and an inspection certificate produced. When replacing damaged components all fasteners that are removed must be replaced with new ones. Care should be taken to ensure ground conditions are suitable to support the replacement posts. Re-compaction of the ground may be required, or driven posts may have to be replaced with concrete foundations. If concrete foundations were not designed to be survivable then they should be inspected to ensure no cracking or movement has occurred. If there is evidence of either, then the foundation should be replaced. In all probability it will be necessary and most practical in these circumstances to install a larger foundation thereby removing all the disturbed ground.

Damaged components should be disposed of in an environmentally responsible way.

Innovation

SAFEROAD lead the VRS market in innovation and continually strive for improvement, so with the passing of time existing installations may not be as per the current drawings, Therefore it is recommended that manuals and drawings from the time of installation should be maintained on file for reference.



Section 6 -
Driven and Foundation
Post Testing Requirements

Ground Conditions

Soil testing must be carried out to establish the strength or compaction of the ground into which the VRS is to be installed. Tests should be carried out in accordance with SAFEROAD's testing procedure as detailed on page 34.

The frequency of testing should be as described in the contract specific appendix 4/1. As a minimum SAFEROAD recommend that at least one test is carried out for each VRS run or one test for every 200m whichever is the greater.

There should be further tests if there is a change in ground conditions for example if the VRS crosses a cut fill line then each ground condition should be tested.

Assuming the ground has been compacted in accordance with MCHW VOL 1 series 600 then standard driven posts or driven foundations should record a pass when the ground is tested. It should be noted that the soil test takes into account the plastic moment of each post type when impacted at the angle of the type test which is the design criteria for VRS. This does not consider the plastic moment of the post through its strongest axis. Therefore, foundations installed to meet the required test criteria may move under impact. If this occurs, they should be replaced when the VRS is repaired.

When installing concrete foundations that are required by the design organisation to be survivable (this should be made clear in appendix 4/1). The deflection for a VRS post in a survivable concrete foundation should be no more than 50mm thereby mitigating the risk of displacement when impacted outside of the parameters set down in the initial type test although there is no guarantee of this.

Soil Testing Criteria

Sigma 100 driven post, driven foundation and concrete foundation

A bending moment of 6.5 kNm (6500Nm) must be achieved before the post deflection exceeds 100mm.

C125 driven post, driven foundation and concrete foundation

A bending moment of 8.5 kNm (8500Nm) must be achieved before the post deflection exceeds 150mm.

C120 driven posts, driven foundation and concrete foundation

A bending moment of 8.5 kNm (8500Nm) must be achieved before the post deflection exceeds 150mm.

C100 with or without stiffener driven post, driven foundation and concrete foundation

A bending moment of 8.5 kNm (8500Nm) must be achieved before the post deflection exceeds 150mm.

C125 x 125 driven post and concrete foundation

A bending moment of 9 kNm (9000Nm) must be achieved before the post deflection exceeds 150mm.

SafeFlex Transition C125 x C125 driven post and concrete foundation

A bending moment of 9 kNm (9000Nm) must be achieved before the post deflection exceeds 150mm.

MegaGuard Post H section foundation only, no driven post available.

A bending moment of 9 kNm (9000Nm) must be achieved before the post deflection exceeds 100mm.

SR A18 driven post, driven foundation and concrete foundation

A bending moment of 6 kNm (6000Nm) must be achieved before the post deflection exceeds 100mm

The deflection should be measured at 610mm. See loading chart page 39.

Recording Foundation Test Results

Foundation test results should be recorded on a test result form an example of this is shown on the next page.

Notes should be made on the form of the testing kit that was used for the test and the identification number of the calibration certificates.



Section 7 -
Post and Foundation soil
Testing Procedure

Soil Testing Criteria

1. The test should be applied in the direction it would be loaded in service. In the case of double-sided barrier, the load should be applied in the direction of the weakest side of the foundation.
2. Check that the gauge is in calibration and the certificate is available.
3. Locate the reaction vehicle in a suitable position. The reaction vehicle can be any suitable vehicle or piece of plant weighing not less than 3 tonnes, - an Orteco rig is adequate. Packing may be required to provide a suitable flat surface to push against. (See Diagram 1 on page 38)
4. Connect the hydraulic pipes to the cylinder ram (A) and the pump (B).
5. Fit the appropriate post top box (C) or post push guide (D) to the cylinder ram.
6. If required fit the extension rod or tube (E) on the other end of the cylinder ram.
7. Place the post box or post guide on the post and position the other end of the assembly against the reaction vehicle or packing, ensuring that the cylinder ram is horizontally level.
8. After checking that the pump is in push mode, gently pump until the assembly is wedged in place, but the pressure on the pump gauge still reads zero.
9. Check that the ram will push against the post centrally and is still level horizontally.
10. Install the datum peg (F) in a direct line from the ram and post.
11. Measure the height of the ram in accordance with the 1.5 metre setback rules (diagram 2 on page 36), then using height to pressure loading chart on page 39 to determine what pressure to pump to, to achieve the desired bending moment.
12. Record the measurement from the datum peg to the post at a height of 610mm. The 610mm height is determined in accordance with the 1.5 metre setback rules (diagram 2 on page 38).
13. Gently apply load using the pump until the gauge reads 1kN (1000 N).
14. Record the new measurement between the datum peg and the post.
15. Increase load in 1kN increments and record findings until
 - (a) The required bending moment is achieved.
 - (b) The post deflection exceeds the permitted allowance.
 - (c) The plastic moment of the post is reached without any lateral movement of the foundation.
16. Record the results on a post test result sheet, an example of which is on page 35.
17. Pass the results over to the client within 48 hrs.

Diagram 1

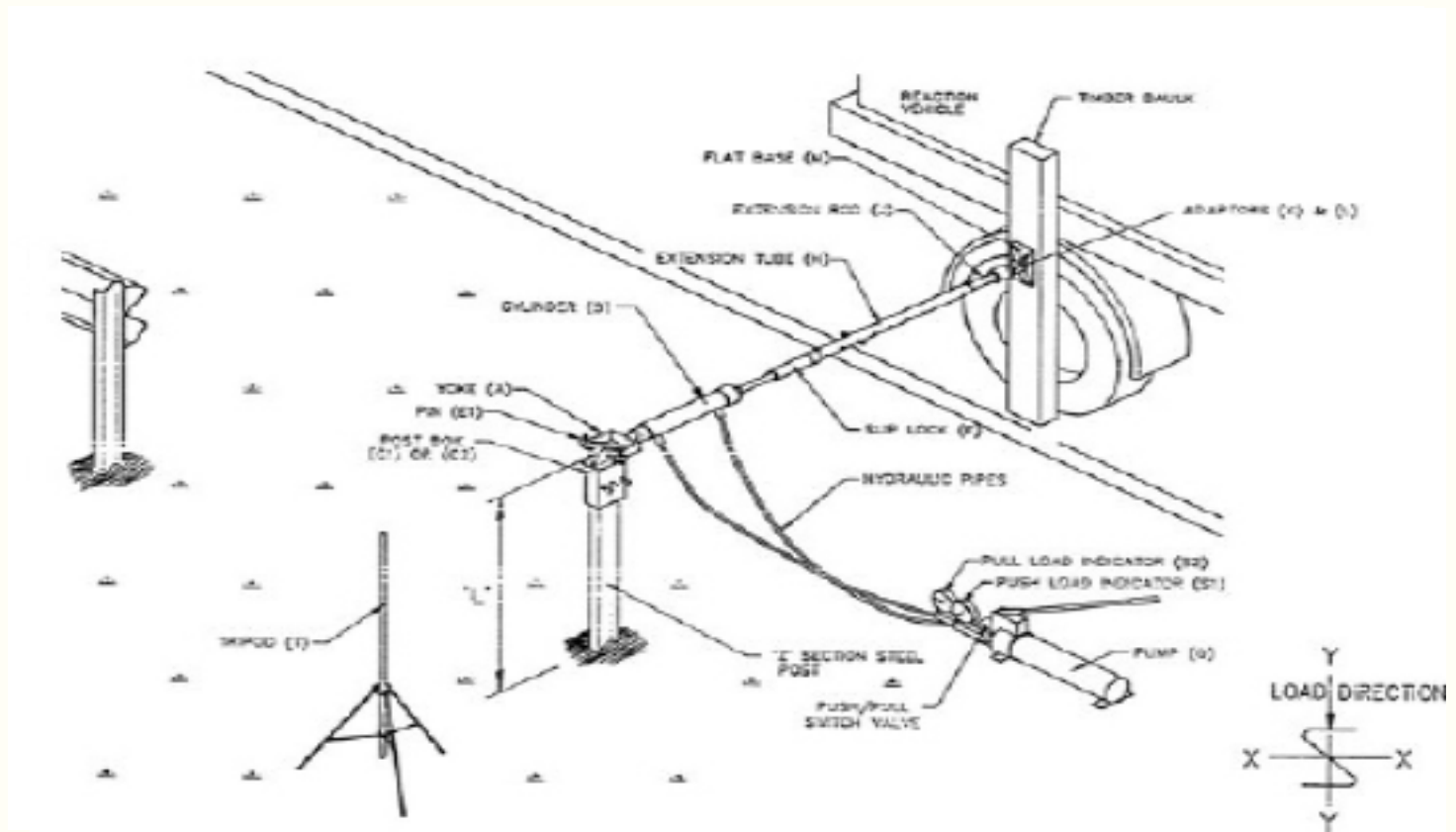
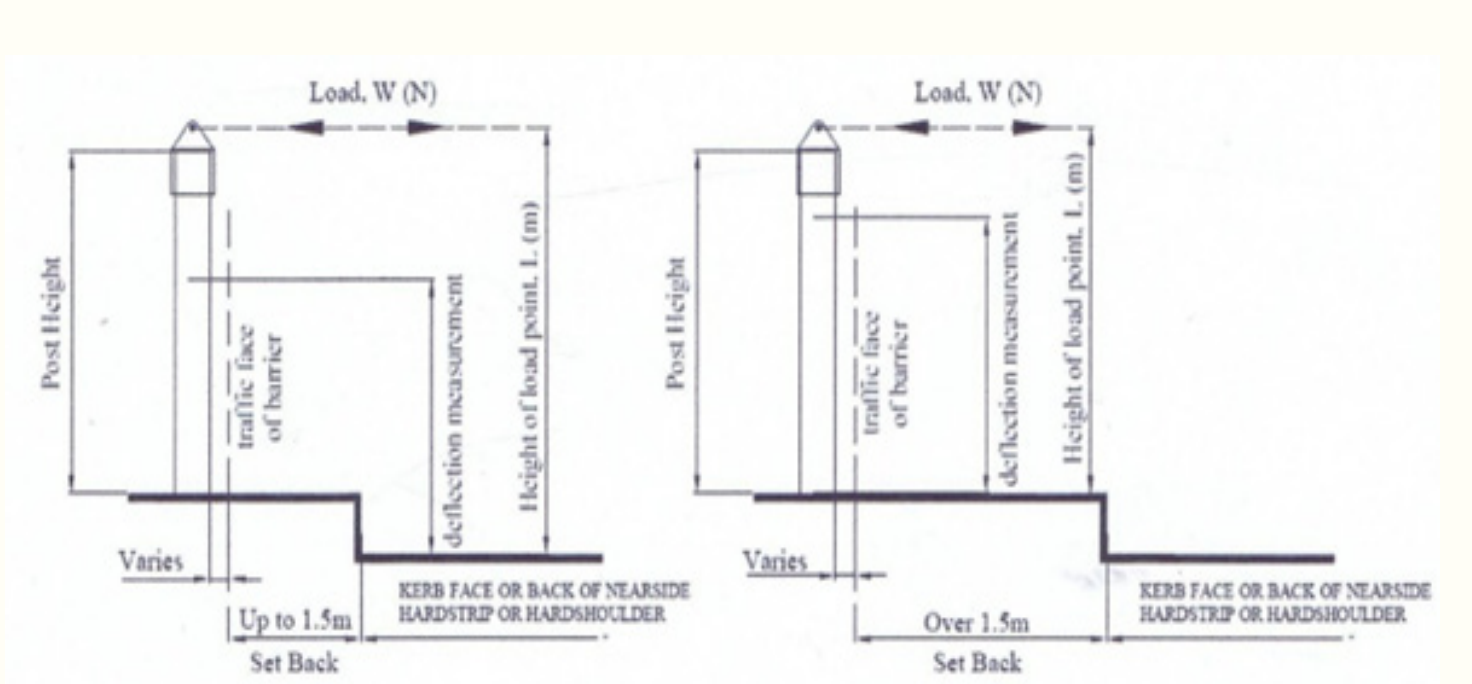

Diagram 2



Pressure Loading

Sigma 100		C100,C120 & C125		C125 x 125		MegaFlex		Mega Guard			
Loading height in mtrs	Pressure in kN	Loading height in mtrs	Pressure in kN	Loading height in mtrs	Pressure in kN	Loading height in mtrs	Pressure in kN	Loading height in mtrs	Pressure in kN	Loading height in mtrs	Pressure in kN
0.60	10.83	0.60	14.17	0.60	15.25	0.60	15.00	0.60	15.25	1.00	9.15
0.61	10.66	0.61	13.93	0.61	15.00	0.61	14.75	0.61	15.00	1.01	9.06
0.62	10.48	0.62	13.71	0.62	14.76	0.62	14.52	0.62	14.76	1.02	8.97
0.63	10.32	0.63	13.49	0.63	14.52	0.63	14.29	0.63	14.52	1.03	8.88
0.64	10.16	0.64	13.28	0.64	14.3	0.64	14.06	0.64	14.3	1.04	8.80
0.65	10.00	0.65	13.08	0.65	14.08	0.65	13.85	0.65	14.08	1.05	8.71
0.66	9.85	0.66	12.88	0.66	13.86	0.66	13.64	0.66	13.86	1.06	8.63
0.67	9.70	0.67	12.69	0.67	13.66	0.67	13.43	0.67	13.66	1.07	8.55
0.68	9.56	0.68	12.5	0.68	13.46	0.68	13.24	0.68	13.46	1.08	8.47
0.69	9.42	0.69	12.32	0.69	13.26	0.69	13.04	0.69	13.26	1.09	8.39
0.70	9.29	0.70	12.14	0.70	13.07	0.70	12.86	0.70	13.07	1.10	8.32
0.71	9.15	0.71	11.97	0.71	12.89	0.71	12.68	0.71	12.89	1.11	8.24
0.72	9.03	0.72	11.81	0.72	12.71	0.72	12.5	0.72	12.71	1.12	8.17
0.73	8.90	0.73	11.64	0.73	12.53	0.73	12.33	0.73	12.53	1.13	8.10
0.74	8.78	0.74	11.49	0.74	12.36	0.74	12.16	0.74	12.36	1.14	8.03
0.75	8.67	0.75	11.33	0.75	12.2	0.75	12.00	0.75	12.2	1.15	7.96
0.76	8.55	0.76	11.18	0.76	12.04	0.76	11.84	0.76	12.04	1.16	7.89
0.77	8.44	0.77	11.04	0.77	11.88	0.77	11.69	0.77	11.88	1.17	7.82
0.78	8.33	0.78	10.90	0.78	11.73	0.78	11.54	0.78	11.73	1.18	7.75
0.79	8.23	0.79	10.76	0.79	11.58	0.79	11.39	0.79	11.58	1.19	7.69
0.80	8.13	0.80	10.63	0.80	11.44	0.80	11.25	0.80	11.44	1.20	7.63
0.81	8.02	0.81	10.49	0.81	11.3	0.81	11.11	0.81	11.3	1.21	7.56
0.82	7.93	0.82	10.37	0.82	11.16	0.82	10.98	0.82	11.16	1.22	7.50
0.83	7.83	0.83	10.24	0.83	11.02	0.83	10.84	0.83	11.02	1.23	7.44
0.84	7.74	0.84	10.12	0.84	10.89	0.84	10.71	0.84	10.89	1.24	7.38
0.85	7.65	0.85	10.00	0.85	10.76	0.85	10.59	0.85	10.76	1.25	7.32
0.86	7.56	0.86	9.88	0.86	10.64	0.86	10.47	0.86	10.64	1.26	7.26
0.87	7.47	0.87	9.77	0.87	10.52	0.87	10.34	0.87	10.52	1.27	7.20
0.88	7.39	0.88	9.66	0.88	10.4	0.88	10.23	0.88	10.4	1.28	7.15
0.89	7.30	0.89	9.55	0.89	10.28	0.89	10.11	0.89	10.28	1.29	7.09
0.90	7.22	0.90	9.44	0.90	10.17	0.90	10.00	0.90	10.17	1.30	7.04
0.91	7.14	0.91	9.34	0.91	10.05	0.91	9.89	0.91	10.05	1.31	6.98
0.92	7.07	0.92	9.24	0.92	9.95	0.92	9.78	0.92	9.95	1.32	6.93
0.93	6.99	0.93	9.14	0.93	9.84	0.93	9.68	0.93	9.84	1.33	6.88
0.94	6.91	0.94	9.04	0.94	9.73	0.94	9.57	0.94	9.73	1.34	6.83
0.95	6.84	0.95	8.95	0.95	9.63	0.95	9.47	0.95	9.63	1.35	6.78
0.96	6.77	0.96	8.85	0.96	9.53	0.96	9.38	0.96	9.53	1.36	6.73
0.97	6.70	0.97	8.76	0.97	9.43	0.97	9.28	0.97	9.43	1.37	6.68
0.98	6.63	0.98	8.67	0.98	9.34	0.98	9.18	0.98	9.34	1.38	6.63
0.99	6.57	0.99	8.59	0.99	9.24	0.99	9.09	0.99	9.24	1.39	6.58
1.00	6.50	1.00	8.50	1.00	9.15	1.00	9.00	1.00	9.15	1.40	6.54

This is the datum bending moment. All calculations are determined from this figure, Divide the datum bending moment by the height in metres to determine the pressure required in kN to achieve the correct loading for that height

Permissible maximum deflections measured at 610mm high

D = Driven Post Or Driven Foundation
C = Compliant Concrete Foundation
S = Survivable Concrete Foundation.
See pages 31 & 37

Sigma 100	
D	100mm
C	100mm
S	50mm

C100,C120 & C125	
D	150mm
C	150mm
S	50mm

MegaFlex	
D	150mm
C	150mm
S	50mm

Mega Guard	
C	100mm
S	50mm

C125 x 125	
D	150mm
C	150mm
S	50mm



Section 8 -
General Arrangement
Drawings



Limited Use Drawings



Steel Step Barrier Drawings

Saferoad UK Ltd are a leading supplier of Vehicle Restraint Systems, for information on our range of products or services please visit www.saferoad-rs.com/uk for more information or scan the QR codes below



Our Services

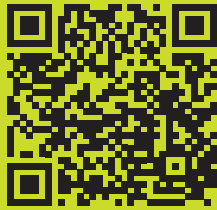

Training



Our Products

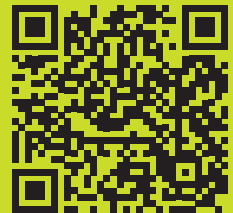

Contact Us



Saferoad UK Ltd
Concord House
Bessemer Way
Scunthorpe
DN15 8XE

Tel: 01724 289119
email: enquiries@saferoad.co.uk